

基于CSU8RP3119的三合一移动电源应用设计[2A] V6.1

同步整流

电池接口与测试点

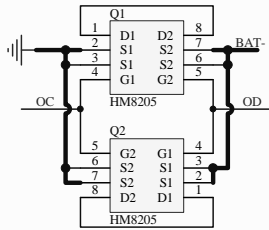
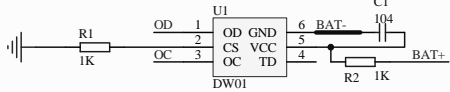
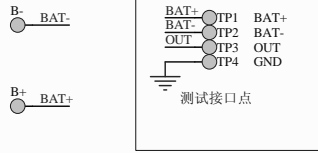

USB插入检测部分

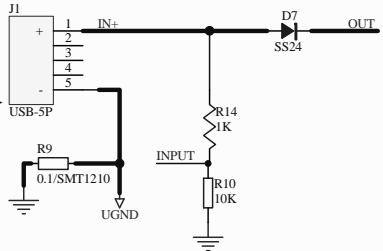

主控部分

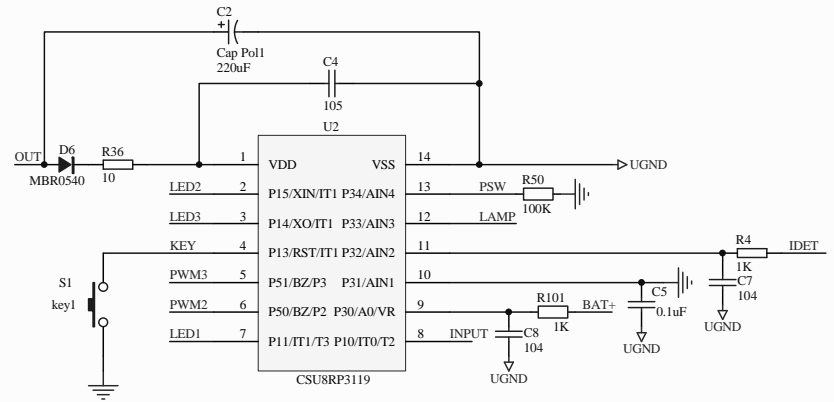

保护电路部分

电量指示部分

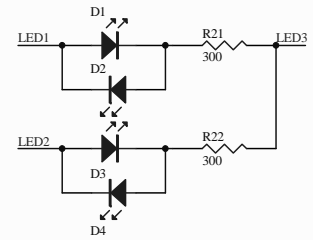

照明部分

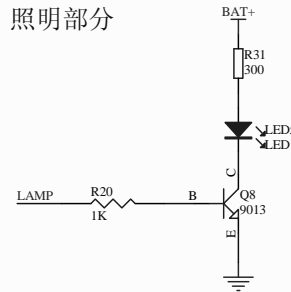

充电、放电回路部分

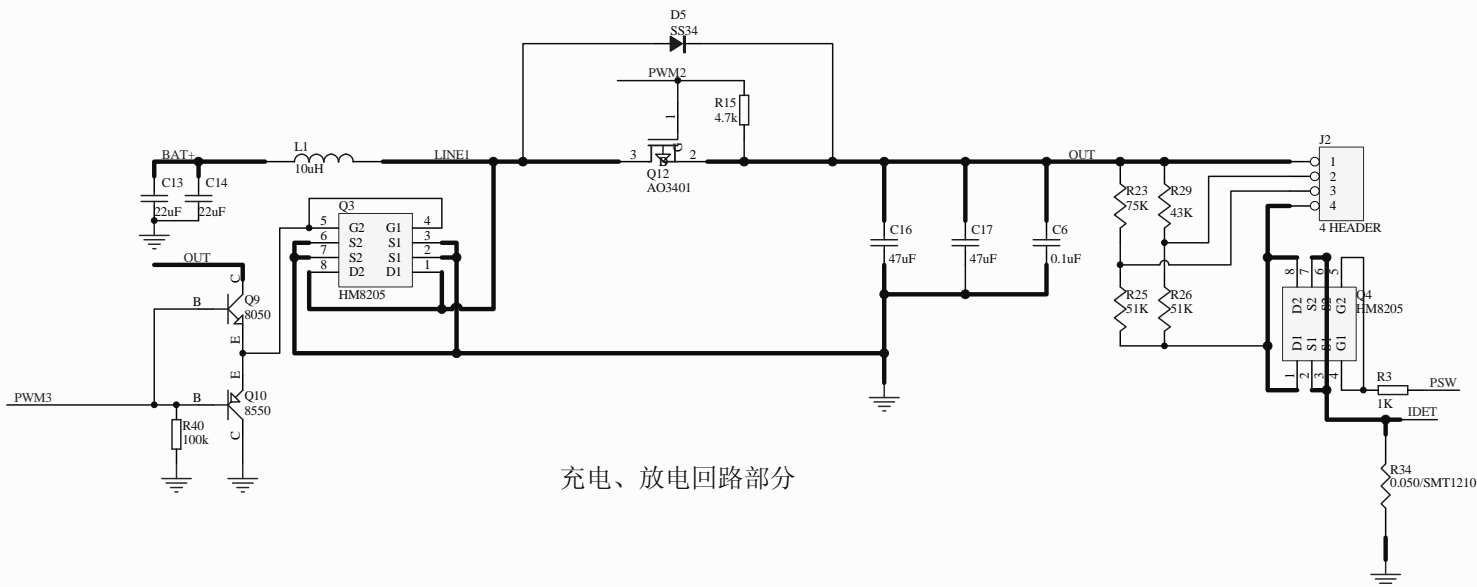

Title		
2014-05-19		
Size	Number	Revision
B	cs power	
Date:	2014-11-5	Sheet of
File:	E:\临时\CSU8RP3119同步整流三合一移动电源V6.1.Sch	1/1